

**KAESER**  
COMPRESSORS®

*Built for a lifetime.*



# Regenerative Desiccant Dryers

**KAD, KED, and KBD Series**

40 to 5400 cfm

**[kaeser.com](http://kaeser.com)**

# Desiccant Air Dryers

## The right dryer for you

Most compressed air applications can achieve the required air quality by using a refrigerated dryer in combination with proper filtration. However, in cases where compressed air is exposed to freezing temperatures or where the product, process, or equipment is highly sensitive to moisture, Kaeser offers a complete line of desiccant dryers specifically designed to meet low dew points and deliver energy savings.

## Innovation you can trust

With a cutting edge research and development team committed to building industry-leading products, Kaeser continues to deliver better solutions to meet our customers' compressed air needs. Kaeser's expertise and world-wide reputation for superior reliability and efficiency offer great performance and peace of mind.

## Quality in every detail

Desiccant dryer performance and reliability are driven by component quality. Kaeser's valves and actuators are designed for consistent dew point performance and low pressure drop. Additionally, desiccant bed symmetry is selected to ensure uniform flow distribution and maximize contact time, while the spherical activated alumina desiccant allows for long service life and minimizes dusting. It also has a high surface-to-volume ratio and great affinity for water vapor for superior adsorption.

## Savings with proper application

Proper planning with the help of Kaeser's system design engineers can save you money on capital and energy costs. Desiccant dryers have a higher purchase price and overall operating costs than refrigerated dryers and should be applied to the portions of a system requiring dew points below that of a refrigerated dryer. Kaeser can design a system that will efficiently deliver air quality suitable for your application.

## Desiccant dryer basic operation

Kaeser desiccant dryers use the principles of adsorption and desorption and alternately cycle the compressed air through twin desiccant towers. As the vapor-laden air flows through one tower, the moisture is adsorbed onto the desiccant. Meanwhile, in the other tower, "purge air" flows through, evaporates the water on the desiccant, and carries it out of the tower as vapor.

## The benefits of counterflow regeneration

Kaeser's upflow drying and downflow regeneration extends desiccant service life and ensures consistent outlet dew points.

Upflow drying also controls the accumulation of liquid water in the desiccant beds. Regardless of design, liquid water will accumulate in the piping between the prefilters and the dryer inlet. Eventually, the air stream will carry a "slug" of water into the desiccant bed.

Counterflow design ensures that the driest portion of the desiccant bed is nearest the dryer outlet at switchover, and allows purge air to be evenly distributed throughout the desiccant bed, providing more effective regeneration.

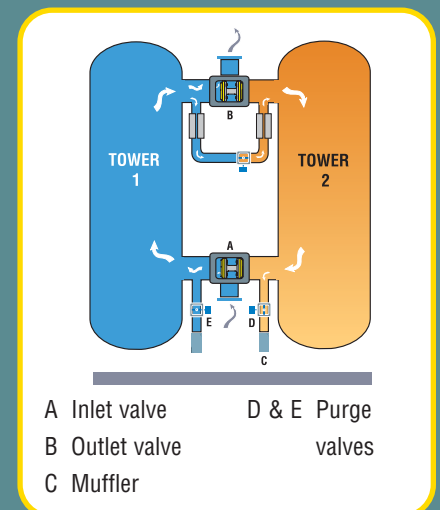



**KAESER**

**KAESER**  
COMPRESSOR  
1-800-279-3247



# Heatless desiccant dryer (KAD)

KADs produce pressure dew points as low as  $-100^{\circ}\text{F}$  at rated conditions (see Dew Point Options on page 5).

Sizes: 40 – 5400 scfm

## Controls and instrumentation

- Tower pressure gauges
- Tower status lights
- Switching failure alarm\*
- Purge flow indicator
- NEMA 4 electrical enclosure
- Ethernet connection - KAD PS
- RS232 comm port\*

\*Not available on KAD E

## Separate top fill and bottom drain ports

- Easy desiccant replacement and removal

## ASME stamped pressure vessels

- Fabricated per Section VIII of the boiler and pressure vessel code
- ASME safety relief valve

## Standard purge pressure adjusting valve

- Offers convenient purge rate adjustment

## Inlet and outlet shuttle valves

- Nylon shuttle
- Tested to over 500,000 cycles
- Corrosion resistant aluminum housing
- Single moving part has very long life
- No maintenance
- No check valves

## Standard moisture indicator

- Color change indicates elevated outlet dew point

## Standard stainless steel support screens and air diffusers

- Located internally at top and bottom of each vessel
- Easy to remove and clean
- Efficiently filters out large contaminants and protects outlet shuttle valve
- Effectively prevents channeling

## Structural steel frame complete with floor stand for easy installation

- Lifting lugs for easy handling
- Optional factory mounting of pre- and after-filters

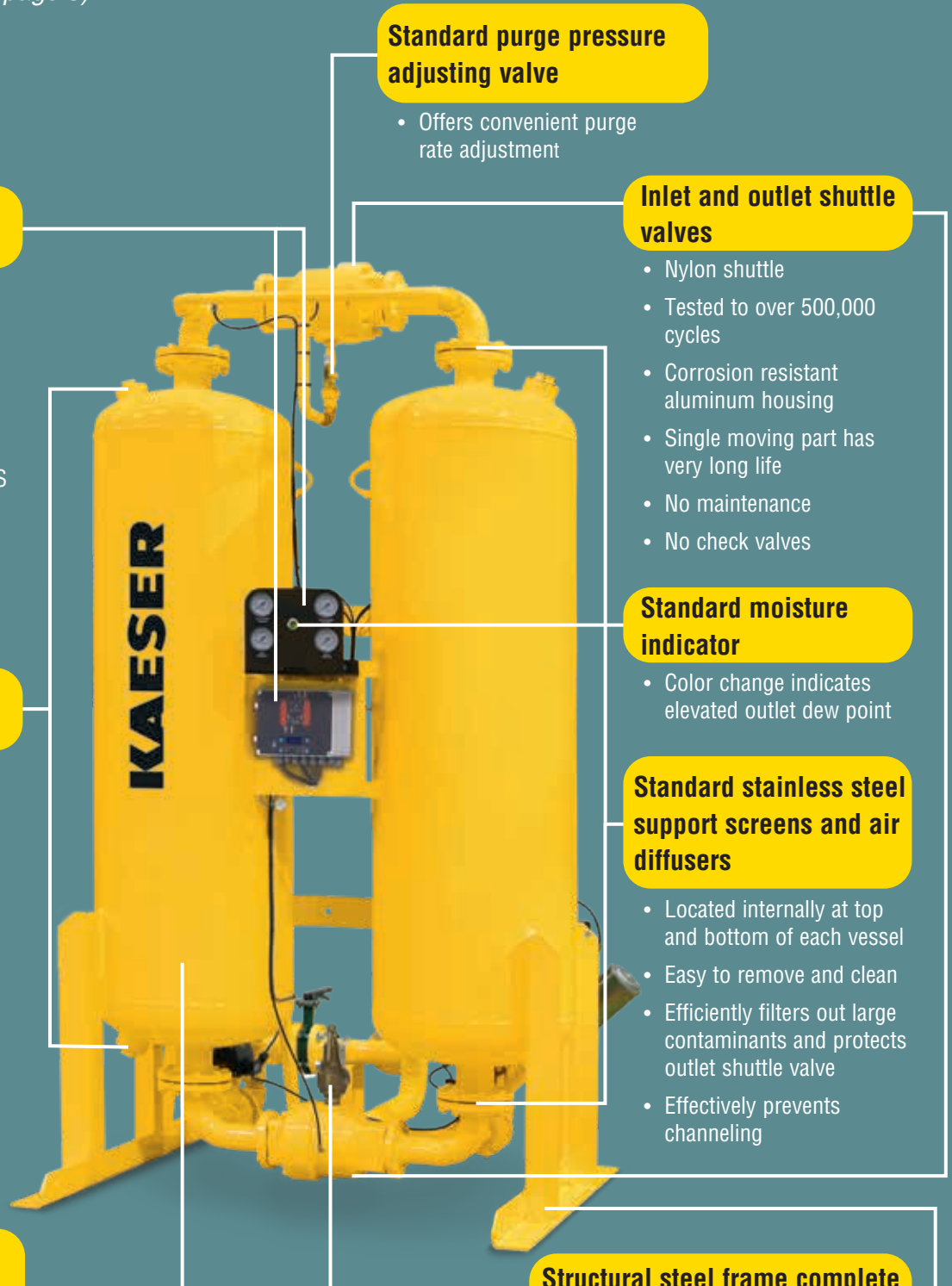

## Heatless desiccant dryer (KAD) (Table 1)

All Models (E and PS)	Inlet Flow @ 100 psig (scfm)	Purge Rate @ 100 psig (scfm)		Outlet Air Flow Rate (scfm)		Power Supply	Dimensions* W x D x H (inches)	Inlet and Outlet Connection* (inches)	Wt. * (lb.)	Filter Package Capacity (scfm)	Total Replacement Desiccant (lb.)
		Avg	Max	Avg	Min						
KAD 40	40	5.8	7	34.2	33.0	120-240 V 1 Ph 50 or 60 Hz	31 x 32 x 49	1 NPT	365	55	52
KAD 60	60	8.6	10.5	51.4	49.5		31 x 32 x 64		445	75	80
KAD 90	90	13	15.8	77.0	74.3		31 x 32 x 81		575	90	110
KAD 115	115	16.6	20.1	98.4	94.9		42 x 38 x 57	685	160	210	
KAD 165	165	23.8	28.9	141	136			685	290		
KAD 260	260	37.4	45.5	223	215		47 x 38 x 75	1010	290	318	
KAD 370	370	53.3	64.8	317	305		55 x 38 x 65	1215	390	458	
KAD 450	450	64.8	78.8	385	371		55 x 38 x 73	1350	500	542	
KAD 590	590	85	103	505	487		49 x 48 x 103	1473	625	710	
KAD 750	750	108	131	642	619		50 x 48 x 107	2134	1250	910	
KAD 930	930	134	163	796	767		55 x 56 x 112	2414	1250	1180	
KAD 1130	1130	163	198	967	932		59 x 56 x 115	2875	1250	1420	
KAD 1350	1350	194	236	1156	1114		60 x 56 x 120	3722	1875	1846	
KAD 1550	1550	223	271	1327	1279		66 x 56 x 116	4167	1875	2064	
KAD 2100	2100	302	368	1798	1733		72 x 56 x 119	4417	2500	2520	
KAD 3000	3000	432	525	2568	2475		76 x 62 x 125	9010	3125	3734	
KAD 4100	4100	590	718	3510	3383		85 x 62 x 124	9900	5000	5398	
KAD 5400	5400	778	945	4622	4455		96 x 66 x 124	12,000	6875	7200	

**Note 1:** KAD dryer inlet flow capacities are established in accordance with CAGI (Compressed Air and Gas Institute) Standard ADF-200: Inlet air pressure 100 psig, inlet air temperature 100°F, saturated.

**Note 2:** The purge flow rate of any pressure swing (heatless) desiccant dryer is not constant throughout the purge cycle. The purge cycle consists of a maximum purge flow period when the purge valve is open and a reduced flow period during repressurization. The total air consumption during the purge cycle is the average purge flow and is based on a 10 minute cycle time (-40°F PDP).

**Note 3:** Maximum working pressure: 150 psig standard; 250 psig optional. Maximum working pressure to 500 psig available for most models. Consult factory.

\*Dryer only. See drawing for inlet/outlet connection size for dryer with filter package. Weight is dryer only. Dryer shipping weight appears on drawing. For shipping with a filter package, consult factory.

## Flow capacities

### Maximum inlet flow capacities at various pressures:

To determine a dryer's inlet flow capacity at inlet pressures other than 100 psig, multiply the dryer's rated inlet flow (found in Table 1) by the multiplier from Table 2 that corresponds to the system pressure at the dryer inlet.

### Outlet flow capacities:

For dryers operating at less than maximum flow and using the Purge Economizer feature and/or operating at pressures other than 100 psig, contact factory for correct purge flow.

**Specifications are subject to change without notice.**

## KAD inlet pressure correction factor (Table 2)

Inlet Pressure (psig)	Multiplier	Inlet Pressure (psig)	Multiplier
60*	0.65	125	1.10
70	0.74	130	1.12
80	0.83	140	1.16
90	0.91	150	1.20
100	1.00	175	1.29
110	1.04	200	1.37
115	1.06	225	1.45
120	1.08	250	1.52

\*For operation at pressures lower than 60 psig, please contact factory.

## (Table 3)

ISO 8573.1 Class	Dew Point	Cycle Time and Mode	
		Standard	with Optional Purge Saver*
1	-94°F (-70°C)	4 min. fixed	N/A
2	-40°F (-40°C)	10 min. fixed	Yes
3	-4°F (-20°C)	16 min. fixed	Yes
4	+38°F (+3°C)	24 min. fixed	No

\* The Purge Saver controller also offers fixed cycle settings

## KAD dew point options meet ISO 8573.1 air quality standards (Table 3)

Models KAD and KAD PS allow the user to select outlet pressure dew points corresponding to four of the different ISO 8573.1 air quality classes.

KAD E models are preset to deliver the commonly used ISO 8573.1 Class 2 outlet pressure dew point.

# Heated desiccant dryers (KED & KBD)

Kaeser Heated Purge Dryers (KED) are heated regenerative dryers that use only 7% of compressed air for purging. They heat the dry purge air to increase its capacity to hold moisture and to regenerate. KED's provide lower operating costs by reducing the amount of expensive purge air used to regenerate. Standard design outlet pressure dew point at rated conditions: -4°F (-40°F with the optional purge booster).

**Sizes: 300 – 3200 scfm**

Kaeser Blower Purge Dryers (KBD) use little or no purge air by introducing atmospheric air and heating it. The heated air has a higher capacity for absorbing water and provides effective regeneration. KBD's provide the greatest energy savings by eliminating the need to use costly compressed air for purging. Standard design outlet pressure dew point at rated conditions: -40°F.

**Sizes: 500 – 4300 scfm standard. Up to 10,000 scfm available, consult factory.**

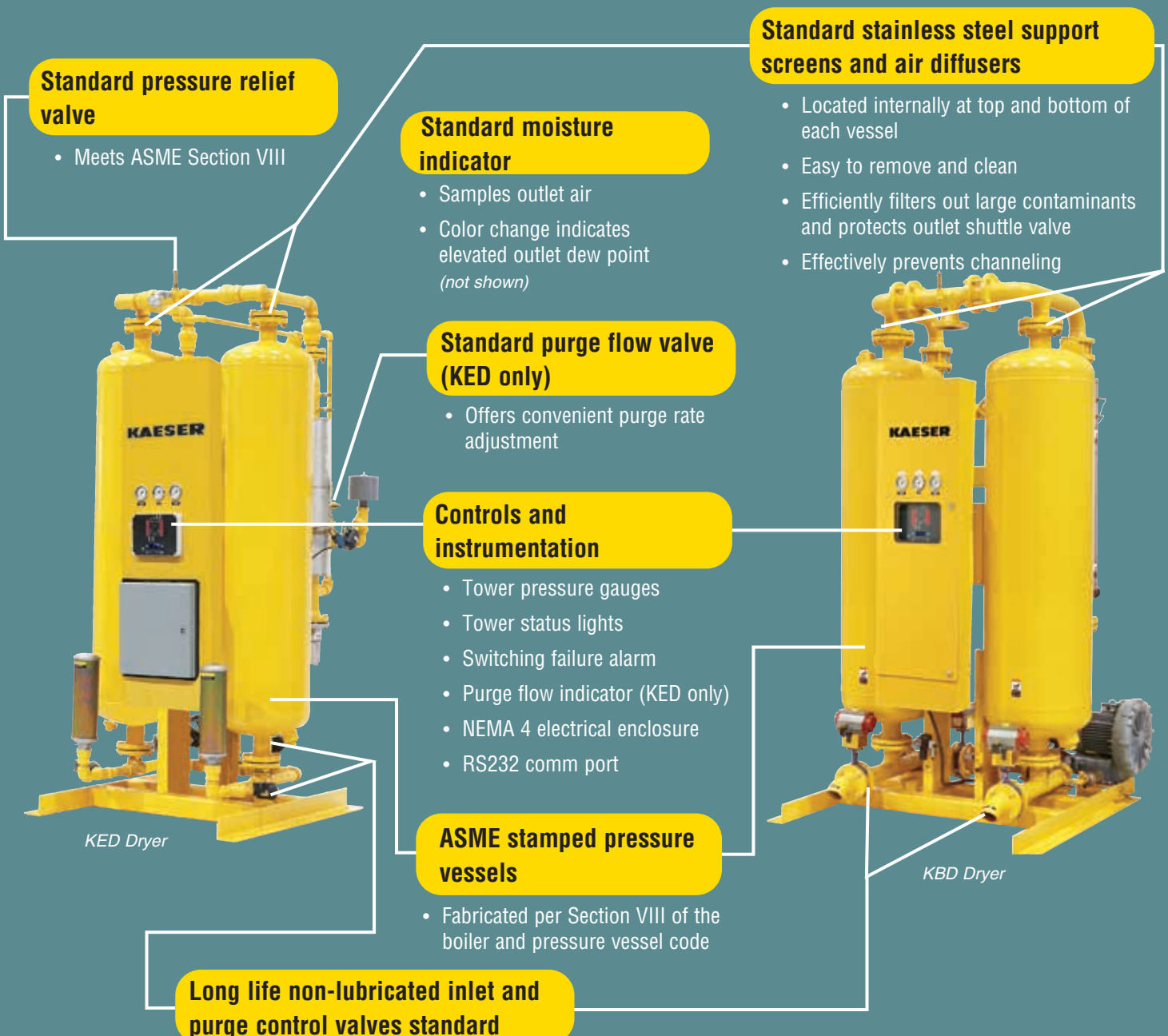

## Kaeser heated purge dryers (KED) (Table 4)

KED Model Number	Inlet flow @ 100 psig 100°F (scfm)	Purge Flow Rate (scfm)	Air Available Average (scfm)	Heater		Dimensions W x D x H (in.)	Approx. Weight* (lb.)	In/Out Connection* (in.)	Pre-filter (KB Series) (scfm)	High-Temp After-filter (HTA Series) (scfm)	Total Replacement Desiccant*** (lb.)		
				(nom kW)	(Avg kW)								
300	300	21	279	4.5	1.5	42 x 42 x 98	1360	1.5 NPT	390	400	420		
400	400	28	372	6	2.0	49 x 48 x 104	1776		500	400	708		
500	500	35	465	7	2.5	49 x 48 x 105	1776	2 NPT	500	600		906	
600	600	42	558	8	3.0	50 x 48 x 108	1978		625	600			
750	750	53	698	10	3.8	55 x 56 x 114	2323	3 FLG	1250	1200	1180		
900	900	63	837	12	4.5	55 x 56 x 114	2323				1420		
1050	1050	74	977	14	5.3	59 x 56 x 113	2816				1848		
1300	1300	91	1209	17	6.5	60 x 56 x 118	3326		1875	1800	2518		
1500	1500	105	1395	19	7.5	72 x 56 x 119	5094				2500	2400	3734
1800	1800	126	1674	23	9.0	72 x 56 x 119	5094						
2200	2200	154	2046	28	11.0	76 x 62 x 127	7753	4 FLG	3125	3000	4754		
2600	2600	182	2418	33	13.0	76 x 62 x 127	7753		3750	4800			
3200	3200	224	2976	40	16.0	85 x 62 x 125	8963						

## Kaeser blower purge dryers (KBD) (Table 5)

KBD Model Number	Inlet flow @ 100 psig 100°F (scfm)	Blower Flow Rate (scfm)	Blower		Heater		Dimensions W x D x H (in.)	Approx. Weight* (lb.)	In/Out * Connection (in.)	Pre-filter (KB Series) (scfm)	High-Temp After-filter (HTA Series) (scfm)	Total Replacement Desiccant (lb.)***
			(nom hp)	(Avg kW)	(nom kW)	(Avg kW)						
500	500	94	2.5	1.6	10	8.5	49 x 48 x 105	1861	2 NPT	500	600	708
600	600	113	4	2.5	12	10.2	50 x 48 x 108	2084		625		906
750	750	140		5	2.2	14	12.6	55 x 56 x 114	2429	3 FLG	1250	1200
900	900	158	2.0		17	14.2	55 x 56 x 114	2445	1420			
1050	1050	183	7.5	2.8	19	16.5	59 x 56 x 113	2966	4 FLG	1875	1800	1848
1300	1300	227		5.3	23	20.5	60 x 56 x 118	3576				2518
1500	1500	281	10	7.5	28	25.4	72 x 56 x 119	5359	4 FLG	2500	2400	3734
1800	1800	317		7.0	33	28.6	72 x 56 x 119	5359				
2200	2200	403	15	5.6	40	36.4	76 x 62 x 127	8018	4/6 FLG**	3125	3000	4754
2600	2600	449		10.3	45	40.6	76 x 62 x 127	8123				
3200	3200	552	7.5	2.8	53	49.8	85 x 62 x 127	9243	6 FLG	3750	4800	5222
3600	3600	614		4.0	58	55.5	85 x 62 x 133	12,095				7088
4300	4300	732		4.4	70	66.1	96 x 66 x 132	13,245				

Average Heater kW (fixed cycle) = [kW required to produce 280°F temperature rise] x [235 min. max heat time] / [240 min drying time]

Average Blower kW (fixed cycle) = [Blower kW] x [235 min. max heat time] / [240 min dryer time] // Average Dryer kW (fixed cycle) = [Average Heater kW] + [Average Blower kW]

Actual kW is less and proportional to the average water load presented to the dryer.

\*Dryer only. See drawing for inlet/outlet connection size for dryer with filter package. Weight is dryer only. Dryer shipping weight appears on drawing. For shipping with a filter package, consult factory. // \*\*KBD 3200 has a 4" FLG inlet and 6" FLG outlet connection. // \*\*\*See manual for replacement desiccant details

## Inlet flow

Inlet Flow capacities shown in the Specifications Table have been established at an inlet pressure of 100 psig (7 bar) and a saturated inlet temperature of 100°F (38°C). To determine maximum inlet flow at other conditions, multiply the inlet flow from the Specifications Table by the multiplier from Table 6 that corresponds to your operating conditions.

## KED/KBD inlet conditions correction factors (Table 6)

Inlet Pressure (psig)	Inlet Temperature °F (°C)						
	60 (15.6)	70 (21.1)	80 (26.7)	90 (32.2)	100 (37.8)	110 (43.3)	120 (48.9)
60	1.03	1.01	0.99	0.80	0.58	0.43	0.32
70	1.10	1.08	1.07	0.94	0.68	0.50	0.37
80	1.17	1.15	1.14	1.08	0.79	0.58	0.43
90	1.24	1.22	1.20	1.18	0.89	0.66	0.49
100	1.30	1.28	1.26	1.24	1.00	0.74	0.55
110	1.36	1.34	1.32	1.30	1.11	0.82	0.61
115	1.39	1.37	1.35	1.33	1.16	0.86	0.64
120	1.42	1.40	1.38	1.36	1.22	0.90	0.67
125	1.45	1.43	1.41	1.39	1.27	0.94	0.70
130	1.48	1.46	1.44	1.42	1.33	0.99	0.74
140	1.53	1.51	1.49	1.47	1.44	1.07	0.80
150	1.58	1.56	1.54	1.52	1.50	1.16	0.87

### Important:

For inlet temperatures above 100°F, we **strongly** recommend installing a trim cooler. Please note that for every 20°F inlet temperature increase, moisture load/dryer size approximately doubles.

# Controls and instrumentation

## Heatless desiccant dryers

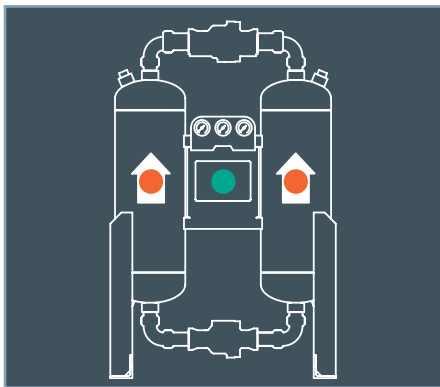

### Basic timer control (KAD E)

The Basic Timer Control is a reliable fixed cycle timer with LED's indicating which tower is drying. This controller maintains a fixed 10-minute cycle delivering an ISO Class 2 pressure dew point (-40°F). Choose this controller when air demand is uniform and closely matches dryer capacity.

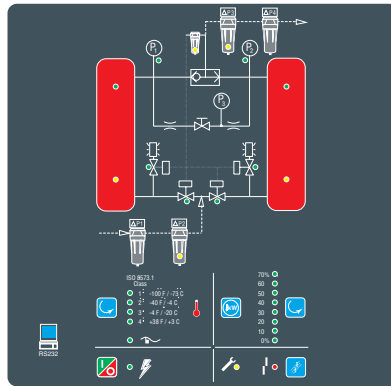

### Standard control (KAD)

The standard controller, with process flow schematic and LED's, makes status checks of control sequence, valves, and filters simple and allows the user to program reminders for routine maintenance intervals. A diagnostic mode steps through the dryer's operational sequence to verify proper function and performance. The display clearly notifies the user if a malfunction occurs.

This controller has four fixed cycle operating modes corresponding to four of the ISO 8573.1 air quality classes for moisture content. In addition, the standard controller includes a manually selectable purge saving feature. The Purge Economizer Switches allow the user to reduce purge consumption in increments of 10% of full purge requirement and down to 30% of dryer capacity, to closely match a constant, fixed load.



### Purge saver control (KAD PS)

To precisely and automatically match purge air consumption to a changing load, Kaeser offers the Purge Saver Control. Having the same features as the Standard Control (except the Purge Economizer Switches), the Purge Saver monitors temperature changes within the desiccant bed when the dryer is operating at less than its full capacity and keeps the towers on-line until the full drying capacity is reached. This reduces the number of purge cycles and ensures that only the necessary volume of purge air is consumed.

In the event of a malfunction with the Purge Saver Control, standard fixed cycle operation is automatically initiated. The KAD PS controller uses Ethernet connection. Dryer operating status is displayed on a two-line vacuum fluorescent text display with choice of three languages: English, Spanish, or French.

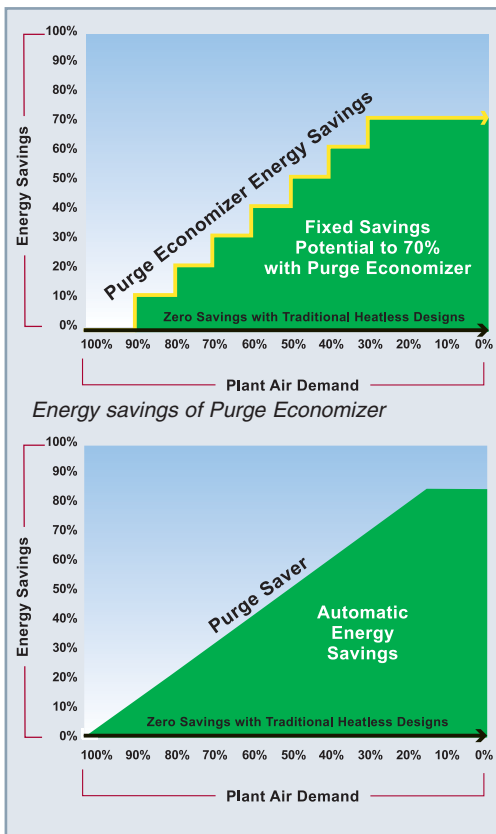



## Externally heated desiccant dryers

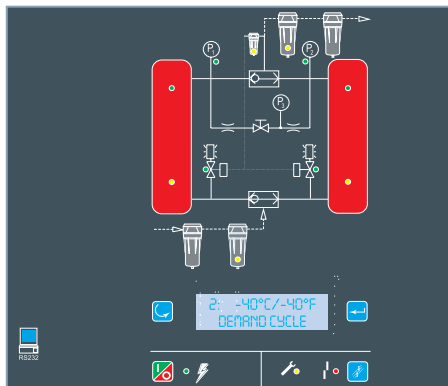

### Standard control (KED and KBD)

The standard controller for heated dryers operates the dryer on a fixed eight-hour cycle. A tower is on-line (drying compressed air) for four hours and then taken off-line to be regenerated during the remaining four hours. Heater operation is terminated when temperature sensors detect that desiccant bed heating is complete. The standard controller's process flow schematic and LED's make status checks of control sequence, valves, and filters simple and allow the user to program reminders for routine maintenance intervals. A diagnostic mode steps through the dryer's operational sequence to verify proper function and performance. The display clearly notifies the user if a malfunction occurs. Dryer operating status is displayed on a two-line vacuum fluorescent text display with choice of three languages: English, Spanish, or French.

### Energy management control (KED and KBD)

The Energy Management Control for heated dryers monitors the moisture level in the desiccant bed and keeps a tower on-line drying compressed air until the desiccant's adsorptive capacity has been fully utilized. Regeneration is then initiated and completed in the following four hours. The regenerated tower repressurizes then sits idle until the Energy Management Control detects full use of the adsorptive capacity of the drying tower and brings the regenerated tower back on-line. For operation at less than full capacity, the Energy Management Control will match power requirement to demand by reducing the frequency of regeneration. Heater operation is terminated when temperature sensors detect that desiccant bed heating is complete. The standard controller's process flow schematic and LED's make status checks of control sequence, valves and filters simple, and allow the user to program reminders for routine maintenance intervals. A diagnostic mode steps through the dryer's operational sequence to verify proper function and performance. The display clearly notifies the user if a malfunction occurs. Dryer operating status is displayed on a two-line vacuum fluorescent text display with choice of three languages: English, Spanish, or French.

## Optional controls

### Heated purge (KED)

#### *Purge booster*

Without increasing the use of compressed air, purge flow can be increased from 7% to 12% with the optional Purge Booster. This device reduces compressed air consumption from 7% to 6% and draws in an equal volume of ambient air mixing it with the purge air. The increased purge airflow produces lower outlet dew points and minimizes dew point spikes.



### Heated purge and blower purge (KED and KBD)

#### *Energy Saver*

The Energy Saver Option integrates moisture and temperature sensors to monitor the humidity level near the outlet end of the desiccant beds. During periods of reduced flow, the Energy Saver extends the drying cycle thereby reducing the number of regeneration cycles, saving energy. For KED models, the Energy Saver Option also includes the Purge Booster.

#### *Energy Management*

The Energy Management Option includes the Energy Saver Option above and a digital dew point monitor. This feature displays the dryer's outlet dew point and allows the user to prevent tower changeover until a user specified outlet dew point has been achieved, or lets the Energy Management determine the length of the drying period. For KED models, the Energy Management Option also includes the Purge Booster.

# Choosing the right desiccant dryer

When selecting desiccant dryers, assess the dew point required for your application and size the dryer for only the part of the system that needs the low dew point.

Heatless dryers (KAD) can achieve the lowest dew points (as low as -100°F) and have lower initial cost, but have higher operating costs. Exhaust purge and blower purge dryers are more efficient, but have higher initial costs, and can only reach dew points as low as -40°F. See the charts below for comparison.

## Operating costs comparison

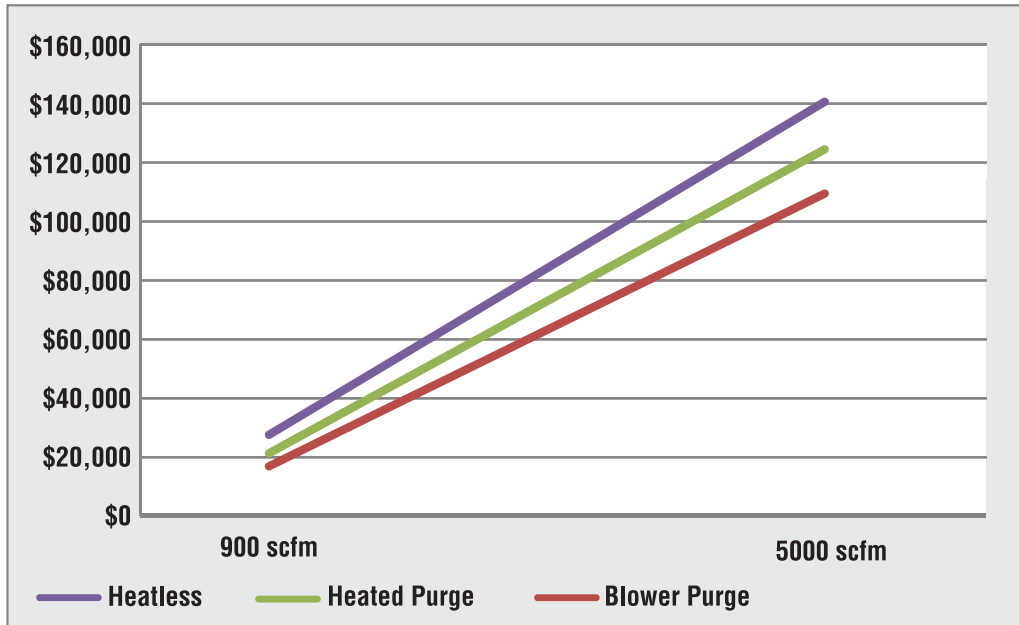

## Total cost of purchase, operation, and maintenance of desiccant dryers

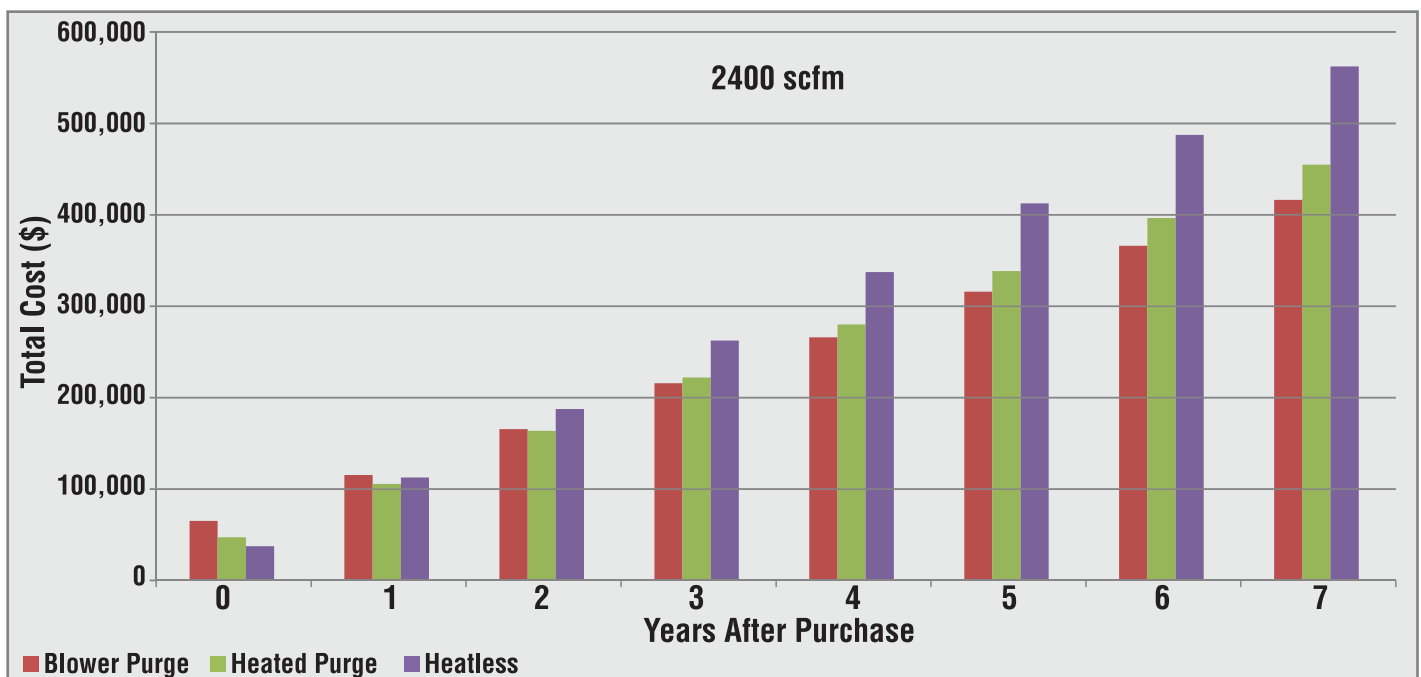

# Options



## Insulation for heated desiccant air dryers (KED and KBD)

Insulation with protective jacket for heater and heater discharge piping is standard; however, insulation for the desiccant vessels is optional. Vessel insulation offers protection for personnel and reduces operating costs. Vessel insulation is flexible open-cell melamine foam having a permanently bonded PVC film laminated polyester fabric jacket. This insulating system absorbs impact and returns to its original shape, thus maintaining its insulating qualities.



## Wall-mountable heatless desiccant air dryers (DC-HF Series)

Reliable, quiet, and efficient, DC-HF series desiccant dryers are available in six models from 7 to 40 scfm. An optional wall-mount bracket is available. Pre-mounted connection adapters allow for easy installation of the included Kaeser filters. Required pressure dew points (-40°F/-94°F) are met in the fixed cycle or with dew point control (optional pdp control kit). Please see the DC-HF literature for more information.

## Filtration



All desiccant dryers require proper filtration. Coalescing pre-filters prevent contamination of desiccant beds by hydrophobic aerosols. Particulate after-filters collect traces of desiccant dust that may exit the dryer. Maintaining these filters extends service intervals and provides excellent air quality. All Kaeser desiccant dryers offer optional filter packages with or without block and bypass valves.

## Other options

### KAD, KED, and KBD

- High humidity alarm
- Mounted dew point monitor
- Stainless steel or copper pilot and instrument air tubing and fittings
- NEMA 4 low ambient protection packages, dryer, and pre-filter(s)
- Parallel piped pre-filters and after-filters with inlet/outlet isolation valves

### KAD

- NEMA 7 Explosion-proof electrical packages



# The world is our home

As one of the world's largest compressed air systems providers and compressor manufacturers, Kaeser Compressors is represented throughout the world by a comprehensive network of branches, subsidiary companies and factory trained partners.

With innovative products and services, Kaeser Compressors' experienced consultants and engineers help customers to enhance their competitive edge by working in close partnership to develop progressive system concepts that continuously push the boundaries of performance and compressed air efficiency. Every Kaeser customer benefits from the decades of knowledge and experience gained from hundreds of thousands of installations worldwide and over ten thousand formal compressed air system audits.

These advantages, coupled with Kaeser's worldwide service organization, ensure that our compressed air products and systems deliver superior performance with maximum uptime.



**KAESER  
COMPRESSORS**®

*Built for a lifetime.*

[www.kaeser.com](http://www.kaeser.com)

**Kaeser Compressors, Inc.**  
511 Sigma Drive  
Fredericksburg, VA 22408 USA  
Telephone: 540-898-5500  
Toll Free: 800-777-7873  
[info.usa@kaeser.com](mailto:info.usa@kaeser.com)

**Kaeser Compressors Canada Inc.**  
3760 La Vérendrye Street  
Boisbriand, QC J7H 1R5 CANADA  
Telephone: (450) 971-1414  
Toll free: (800) 477-1416  
[info.canada@kaeser.com](mailto:info.canada@kaeser.com)

**Kaeser Compresores de México  
S de RL de CV**  
Calle 2 #123  
Parque Industrial Jurídica  
76100 Querétaro, Qro.  
Telephone: 01 (442) 218 64 48  
[sales.mexico@kaeser.com](mailto:sales.mexico@kaeser.com)

**Kaeser Compresores de  
Guatemala y Cia. Ltda.**  
Calz. Atanasio Tzul 21-00, zona 12  
El Cortijo II, Bodega 501  
01012-Guatemala City  
Telephone: +502 2412-6000  
[info.guatemala@kaeser.com](mailto:info.guatemala@kaeser.com)

